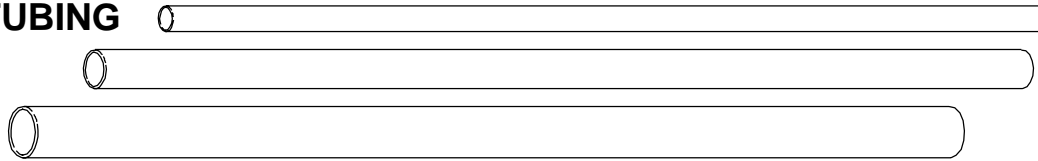

TABLE OF CONTENTS

Bulk Head Adapters	G6
Compressed Air Fittings	G11
Compressed Air Filter-Regulators	G12
Couplings	G2
Dampers-Vacuum Regulators	G6
Diverter Units	G7
Elbows	G4
Entrance Tubes	G6
Filters, Inline	G8
Hose Clamps	G9
Hose Products	G9-10
Maintenance Supplies	G7
Mufflers	G8
Reducing Adapters	G3
Reducing Couplings	G3
Slide Gates	G6
T-Joints	G5
Tube- Brackets	G7
Tube- Caps	G6,8
Tube- Clamps	G7
Tube- Clear Rigid	G2
Tube- Compressed Air	G10
Tube- Extensions	G2
Tube- Vinyl	G10
U-Bends	G4
Waste Containers	G8
Y-Joints	G5

CLEAR RIGID TUBING



- LIGHTWEIGHT, CRYSTAL CLEAR, & HIGHLY IMPACT RESISTANT
- SMOOTH FACTORY-FINISHED TUBE ENDS
- SMOOTH, SNAG-FREE INTERIOR & EXTERIOR SURFACES
- ADAPTABLE TO VACUUM AND BLOWER SYSTEMS
- IDEAL FOR THE TRANSPORT OF PRODUCT & WASTE MATERIAL
- TRANSPARENT FOR EASY-TO-SEE TRANSPORT FLOW

TUBE SIZE		WALL THICKNESS	WEIGHT PER FOOT	SIZE NUMBER	PART NUMBER		
OD INCHES	ID INCHES				4 FT. LENGTH	6 FT. LENGTH	12 FT. LENGTH
1/2	3/8	1/16	.046	CRT050T	04250-01	04250-02	04250-03
5/8	3/8	1/8	.105	CRT062	04252-01	04252-02	04252-03
5/8	1/2	1/16	.059	CRT062T	04254-01	04254-02	04254-03
3/4	1/2	1/8	.132	CRT075	04256-01	04256-02	04256-03
3/4	5/8	1/16	.073	CRT075T	04258-01	04258-02	04258-03
7/8	5/8	1/8	.157	CRT087	04260-01	04260-02	04260-03
7/8	3/4	1/16	.086	CRT087T	04262-01	04262-02	04262-03
1	3/4	1/8	.188	CRT100	04264-01	04264-02	04264-03
1	7/8	1/16	.100	CRT100T	04266-01	04266-02	04266-03
1-1/8	7/8	1/8	.210	CRT112	04267-01	24267-02	04267-03
1-1/4	1	1/8	.237	CRT125	04268-01	04268-02	04268-03
1-1/2	1-1/4	1/8	.288	CRT150	04270-01	04270-02	04270-03
1-3/4	1-1/2	1/8	.340	CRT175	04272-01	04272-02	04272-03
2	1-3/4	1/8	.394	CRT200	04274-01	04274-02	04274-03
2-1/4	2	1/8	.446	CRT225	04276-01	04276-02	04276-03
2-3/8	2-1/8	1/8	.472	CRT237	04278-01	04278-02	04278-03
2-1/2	2-1/4	1/8	.500	CRT250	04280-01	04280-02	04280-03
2-5/8	2-3/8	1/8	.524	CRT262	04282-01	04282-02	04282-03
2-3/4	2-1/2	1/8	.550	CRT275	04284-01	04284-02	04284-03
3	2-3/4	1/8	.604	CRT300	04286-01	04286-02	04286-03
3-1/4	3	1/8	.655	CRT325	04288-01	04288-02	04288-03
3-1/2	3-1/4	1/8	.707	CRT350	04290-01	04290-02	04290-03
4	3-3/4	1/8	.812	CRT400	04292-01	04292-02	04292-03
5	4-3/4	1/8	1.021	CRT500	04294-01	04294-02	04294-03
6	5-3/4	1/8	1.230	CRT600	04296-01	04296-02	04296-03

- Available in standard lengths of 4, 6 and 12 feet.
- Custom lengths also available up to 12 feet.
- Lengths up to 6 feet shipped UPS; over 6 feet by common carrier.
- Please specify outside and inside dimensions.

COUPLINGS

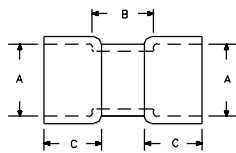

A-FOR TUBE OD	B	C	APPROX. WEIGHT EA.	PART NUMBER
1/2	3/4	1/2	.010	BC20-050
5/8	3/4	1/2	.013	BC20-062
3/4	3/4	1/2	.026	BC20-075
7/8	3/4	1/2	.021	BC20-087
1	1	3/4	.045	BC20-100
1-1/8	1	3/4	.051	BC20-112
1-1/4	1	1	.076	BC20-125
1-1/2	1-1/2	1-1/2	.093	BC20-150
1-3/4	1-1/2	1-1/2	.125	BC20-175
2	1	1-1/2	.147	BC20-200
2-1/4	1-1/2	1-1/2	.164	BC20-225
2-3/8	1-1/2	1-1/2	.174	BC20-237
2-1/2	1-1/2	1-1/2	.182	BC20-250
2-3/4	1-1/2	1-1/2	.205	BC20-275
3	1-1/2	1-1/2	.222	BC20-300
3-1/4	1-1/2	1-1/2	.250	BC20-325
3-1/2	1-1/2	1-1/2	.265	BC20-350
4	1-1/2	1-1/2	.435	BC20-400
5	2	2	.552	BC20-500
6	2	2	.663	BC20-600

Friction fit. Can be clamped or glued. Constructed from Templex Clear Rigid Tubing. Standard Wall Thickness 1/8" inch.

TUBE EXTENSIONS

Style E10 Single Bell



Style E20 Double Bell



Please Specify Dimensions A, B & C When Ordering
Available for All Sizes of Clear Rigid Tubing

REDUCING ADAPTERS

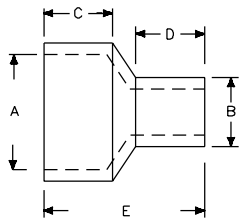

Standard Wall thickness of 1/8 inch. Please specify inside and outside dimensions. (For products with dimensions other than those specified, please contact Templex for availability).

A-ID	B-OD	C	D	E	APPROX. WEIGHT	PART NUMBER
3/4	1/2	3/4	1	2	.007	RA075050
3/4	5/8	3/4	1	2	.016	RA075062
3/4	3/4	3/4	1	2	.021	RA075075
7/8	5/8	3/4	1	2	.016	RA087062
7/8	3/4	1	1	2-1/4	.025	RA087075
1	5/8	3/4	1	2	.016	RA100062
1	3/4	3/4	1	2	.022	RA100075
1	7/8	1	1	2-1/4	.029	RA100087
1-1/8	3/4	3/4	1	2-1/4	.025	RA112075
1-1/8	7/8	1	1	2-1/4	.029	RA112087
1-1/8	1	1	1	2-1/4	.034	RA112100
1-1/4	3/4	3/4	1	2-1/4	.025	RA125075
1-1/4	7/8	1	1	2-1/4	.029	RA125087
1-1/4	1	1	1	2-1/4	.034	RA125100
1-1/4	1-1/8	1	1	2-1/4	.038	RA125112
1-1/2	1	1	1-1/4	2-7/8	.043	RA150100
1-1/2	1-1/8	1	1-1/4	2-7/8	.049	RA150112
1-1/2	1-1/4	1-1/4	1-1/2	3	.060	RA150125
1-5/8	1-1/2	1-1/2	1-1/2	3-1/4	.070	RA162150
1-3/4	1-1/4	1-1/4	1-1/2	3-3/8	.067	RA175125
1-3/4	1-1/2	1-1/4	1-1/2	3	.072	RA175150
2	1-1/4	1-1/4	1-1/2	3-5/8	.072	RA200125
2	1-1/2	1-1/2	1-1/2	3-5/8	.086	RA200150
2	1-3/4	1-1/2	1-1/2	3-1/4	.091	RA200175
2-1/4	1-1/2	1-1/4	1-1/2	3-5/8	.086	RA225150
2-1/4	1-3/4	1-1/2	1-1/2	3-5/8	.100	RA225175
2-1/4	2	1-1/2	1-1/2	3-1/4	.107	RA225200
2-3/8	1-3/4	1-1/2	1-1/2	3-3/4	.105	RA237175
2-3/8	2	1-1/2	1-1/2	3-5/8	.119	RA237200
2-3/8	2-1/4	1-1/2	1-1/2	3-1/4	.120	RA237225
2-1/2	1-3/4	1-1/2	1-1/2	3-7/8	.108	RA250175
2-1/2	2	1-1/2	1-1/2	3-5/8	.119	RA250200
2-1/2	2-1/4	1-1/2	1-1/2	3-1/4	.120	RA250225
2-1/2	2-3/8	1-1/2	1-1/2	3-1/4	.126	RA250237
2-3/4	2	1-1/2	1-1/2	3-7/8	.127	RA275200
2-3/4	2-1/4	1-1/2	2	4-1/8	.153	RA275225
2-3/4	2-3/8	1-1/2	2	4	.156	RA275237
2-3/4	2-1/2	1-1/2	2	3-3/4	.154	RA275250
3	2	1-1/2	2	4-5/8	.152	RA300200
3	2-1/4	1-1/2	2	4-3/8	.162	RA300225
3	2-3/8	1-1/2	2	4	.156	RA300237
3	2-1/2	1-1/2	2	4-1/8	.169	RA300250
3	2-3/4	1-1/2	2	3-3/4	.172	RA300275
3-1/4	2-1/4	1-1/2	2	4-5/8	.170	RA325225
3-1/4	2-3/8	1-1/2	2	4-1/2	.176	RA325237
3-1/4	2-1/2	1-1/2	2	4-3/8	.179	RA325250
3-1/4	2-3/4	1-1/2	2	4-1/8	.185	RA325275
3-1/4	3	1-1/2	2	3-3/4	.187	RA325300
3-1/2	2-1/2	1-1/2	2	4-5/8	.188	RA350250
3-1/2	2-3/4	1-1/2	2	4-3/8	.201	RA350275
3-1/2	3	1-1/2	2	4-1/8	.206	RA350300
3-1/2	3-1/4	1-1/2	2	3-3/4	.206	RA350325
4	2	1	2	3-3/4	.140	RA400200
4	3	1-1/2	2	4-5/8	.230	RA400300
4	3-1/4	1-1/2	2	4-3/8	.240	RA400325
4	3-1/2	1-1/2	2-1/2	4-5/8	.271	RA400350
5	2-1/2	1-1/2	2-1/2	5	.164	RA500250
5	3	1-1/2	2-1/2	6	.278	RA500300
5	3-1/2	1-1/2	3	6	.287	RA500350
5	4	1-1/2	3	5-5/8	.375	RA500400
6	4	1-1/2	3		.472	RA600400
6	5	1-1/2	3	5-5/8	.476	RA600500

REDUCING COUPLINGS

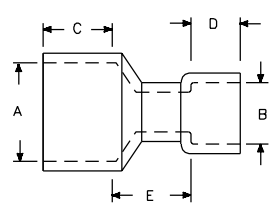

Standard Wall thickness of 1/8 inch. Please specify inside and outside dimensions. (For products with dimensions other than those specified, please contact Templex for availability).

A-ID	B-ID	C	D	E	PART NUMBER
3/4	1/2	3/4	3/4	1	RC075050
3/4	5/8	3/4	3/4	1	RC075062
7/8	5/8	3/4	3/4	1	RC087062
7/8	3/4	1	1	1	RC087075
1	5/8	3/4	3/4	1	RC100062
1	3/4	3/4	1	1	RC100075
1	7/8	1	1	1	RC100087
1-1/8	3/4	3/4	1	1	RC112075
1-1/8	7/8	1	1	1	RC112087
1-1/8	1	1	1	1	RC112100
1-1/4	3/4	3/4	1	1-1/4	RC125075
1-1/4	7/8	1	1	1-1/4	RC125087
1-1/4	1	1	1	1-1/4	RC125100
1-1/4	1-1/8	1	1	1-1/4	RC125112
1-1/2	1	1	1	1-1/2	RC150100
1-1/2	1-1/8	1	1	1-1/2	RC150112
1-1/2	1-1/4	1-1/4	1-1/4	1-1/2	RC150125
1-5/8	1-1/2	1-1/2	1-1/2	1-1/2	RC162150
1-3/4	1-1/4	1-1/4	1-1/4	1-1/2	RC175125
1-3/4	1-1/2	1-1/4	1-1/2	1-1/2	RC175150
2	1-1/4	1-1/4	1-1/4	2	RC200125
2	1-1/2	1-1/2	1-1/2	1-1/2	RC200150
2	1-3/4	1-1/2	1-1/2	1-1/2	RC200175
2-1/4	1-1/2	1-1/4	1-1/2	2	RC225150
2-1/4	1-3/4	1-1/2	1-1/2	1-1/2	RC225175
2-1/4	2	1-1/2	1-1/2	1-1/2	RC225200
2-3/8	1-3/4	1-1/2	1-1/2	1-1/2	RC237175
2-3/8	2	1-1/2	1-1/2	1-1/2	RC237200
2-3/8	2-1/4	1-1/2	1-1/2	1-1/2	RC237225
2-1/2	1-3/4	1-1/2	1-1/2	2	RC250175
2-1/2	2	1-1/2	1-1/2	1-1/2	RC250200
2-1/2	2-1/4	1-1/2	1-1/2	1-1/2	RC250225
2-1/2	2-3/8	1-1/2	1-1/2	1-1/2	RC250237
2-3/4	2	1-1/2	1-1/2	2	RC275200
2-3/4	2-1/4	1-1/2	1-1/2	1-1/2	RC275225
2-3/4	2-3/8	1-1/2	1-1/2	1-1/2	RC275237
2-3/4	2-1/2	1-1/2	1-1/2	1-1/2	RC275250
3	2	1-1/2	1-1/2	2	RC300200
3	2-1/4	1-1/2	1-1/2	2	RC300225
3	2-3/8	1-1/2	1-1/2	2	RC300237
3	2-1/2	1-1/2	1-1/2	2	RC300250
3	2-3/4	1-1/2	1-1/2	2	RC300275
3-1/4	2-1/4	1-1/2	1-1/2	2	RC325225
3-1/4	2-3/8	1-1/2	1-1/2	2	RC325237
3-1/4	2-1/2	1-1/2	1-1/2	2	RC325250
3-1/4	2-3/4	1-1/2	1-1/2	2	RC325275
3-1/4	3	1-1/2	1-1/2	2	RC325300
3-1/2	2-1/2	1-1/2	1-1/2	2-1/2	RC350200
3-1/2	2-3/4	1-1/2	1-1/2	2	RC350250
3-1/2	3	1-1/2	1-1/2	2	RC350275
3-1/2	3-1/4	1-1/2	1-1/2	2	RC350300
3-1/2	3-1/4	1-1/2	1-1/2	2	RC350325
4	2	1	1-1/2	2	RC400200
4	3	1-1/2	1-1/2	2	RC400300
4	3-1/4	1-1/2	1-1/2	2	RC400325
4	3-1/2	1-1/2	1-1/2	2	RC400350
5	2-1/2	1-1/4	1-1/2	3	RC500250
5	3	1-1/2	1-1/2	2-1/2	RC500300
5	3-1/2	1-1/2	1-1/2	2-1/2	RC500350
5	4	1-1/2	2	2	RC500400
6	4	1-1/2	2	3-1/2	RC600400
6	5	1-1/2	2	2	RC600500

90 DEGREE LONG RADIUS ELBOWS

ELBOW SIZE (OD)	LEG *A	LENGTH *B	ELBOW RADIUS R	APPROX. WEIGHT EACH	PART NUMBER		
					PLAIN ENDS	SINGLE BELL	DOUBLE BELL
1-1/2	7	7	1-3/4	.24	NPL150	NSB150	NDB150
2	7	7	1-1/4	.33	NPL200	NSB200	NDB200
2-1/4	7-1/4	7-1/4	1-5/16	.44	NPL225	NSB225	NDB225
2-3/8	8-1/2	8-1/2	2-1/2	.45	NPL237	NSB237	NDB237
2-1/2	8	8	1-5/8	.45	NPL250	NSB250	NDB250
2-3/4	8-1/2	8-1/2	2	.54	NPL275	NSB275	NDB275
3	8-3/4	8-3/4	2	.55	NPL300	NSB300	NDB300
3-1/4	9	9	2	.60	NPL325	NSB325	NDB325
3-1/2	9-3/4	9-3/4	2-1/2	.71	NPL350	NSB350	NDB350
4	10	10	2-1/2	.87	NPL400	NSB400	NDB400
5	13-1/2	13-1/2	4-3/4	1.78	NPL500	NSB500	NDB500
6	16	16	6	1.83	NPL600	NSB600	NDB600

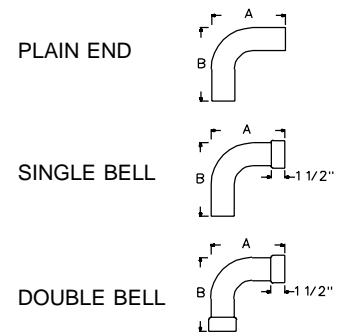

90 DEGREE SHORT RADIUS ELBOWS

ELBOW SIZE (OD)	LEG *A	LENGTH *B	R RADIUS	APPROX. WEIGHT EACH	PART NUMBER		
					PLAIN ENDS	SINGLE BELL	DOUBLE BELL
3/4	2-1/4	2-1/4	1/4	.07	RPL075	RSB075	RDB075
1	4	4	1/2	.09	RPL100	RSB100	RDB100
1-1/4	4-1/2	4-1/2	3/8	.18	RPL125	RSB125	RDB125
1-1/2	4	4	1/4	.21	RPL150	RSB150	RDB150
1-3/4	5	5	5/16	.26	RPL175	RSB175	RDB175
2	5-1/2	5-1/2	1/2	.30	RPL200	RSB200	RDB200
2-3/8	6-1/2	6-1/2	1/2	.39	RPL237	RSB237	RDB237
2-1/2	6-3/4	6-3/4	1/2	.41	RPL250	RSB250	RDB250

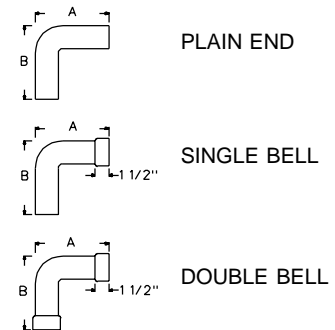

45 DEGREE ELBOWS

ELBOW SIZE (OD)	LEG *A	LENGTH *B	APPROX. WEIGHT EACH	PART NUMBER		
				PLAIN ENDS	SINGLE BELL	DOUBLE BELL
1	2-3/4	2-3/4	.08	FPL100	FSB100	FDB100
1-1/2	3	3	.20	FPL150	FSB150	FDB150
2	4-1/2	4-1/2	.23	FPL200	FSB200	FDB200
2-1/4	3-3/4	3-3/4	.29	FPL225	FSB225	FDB225
2-3/8	3-3/4	3-3/4	.31	FPL237	FSB237	FDB237
2-1/2	4	4	.33	FPL250	FSB250	FDB250
2-3/4	4	4	.37	FPL275	FSB275	FDB275
3	4-1/4	4-1/4	.45	FPL300	FSB300	FDB300
3-1/4	4-1/2	4-1/2	.52	FPL325	FSB325	FDB325
3-1/2	4-3/4	4-3/4	.56	FPL350	FSB350	FDB350
4	5	5	.67	FPL400	FSB400	FDB400
5	6	6	1.02	FPL500	FSB500	FDB500
6	7	7	1.43	FPL600	FSB600	FDB600

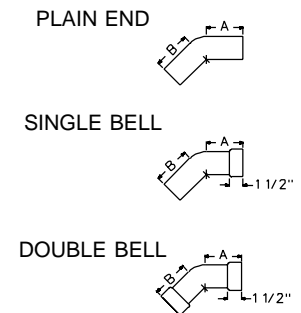

U BENDS

TUBE SIZE (OD)	U-BEND TYPE	R BEND RADIUS	DIMENSIONS			PART NUMBER		
			A	*B (STD.)	*C (STD.)	PLAIN ENDS	SINGLE BELL	DOUBLE BELL
1/2	1	1/2	1	3-3/4	3-3/4	04580	04581	04582
3/4	2	1/4	4-1/2	3-1/2	3-1/2	04583	04584	04585
1	1	3	5-3/4	6	6	04500	04501	04502
1-1/2	1	1-1/2	3	6-1/2	6-1/2	04586	04587	04588
1-1/2	2	1/4	5-3/4	5-1/2	5-1/2	04504	04505	04506
2	1	2-1/2	5	8-1/4	8-1/4	04508	04509	04510
2-1/4	1	1-3/8	2-3/4	7-1/4	7-1/4	04512	04513	04514
2-3/8	1	3-3/8	6-3/4	9-1/4	9-1/4	04520	04521	04522
2-3/8	2	2-1/2	9-1/16	9-1/4	9-1/4	04524	04525	04526
2-1/2	1	2-3/4	5-3/8	9	9	04528	04529	04530
2-1/2	2	1-5/8	9	7-3/4	7-3/4	04532	04533	04534
3-1/4	1	2-1/2	5	10-1/2	10-1/2	04536	04537	04538
4	1	1-7/8	6-1/4	10-5/8	10-5/8	04589	04590	04591

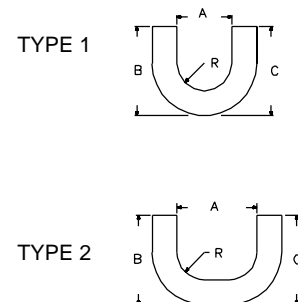

Dimensions are for Plain End Leg. For Legs with a Bell subtract 1/4" from stated leg length.

T - JOINTS

A	B	C	APPROX. WEIGHT EACH	PART NUMBER		
				STYLE TJ20	STYLE TJ22	STYLE TJ23
1/2	1-1/2	1/2	.01	TJ20-050	TJ22-050	TJ23-050
5/8	1-7/8	5/8	.02	TJ20-062	TJ22-062	TJ23-062
3/4	2-1/4	3/4	.04	TJ20-075	TJ22-075	TJ23-075
7/8	2-5/8	7/8	.05	TJ20-087	TJ22-087	TJ23-087
1	3	1	.07	TJ20-100	TJ22-100	TJ23-100
1-1/8	3-3/8	1-1/8	.09	TJ20-112	TJ22-112	TJ23-112
1-1/4	3-3/4	1-1/4	.11	TJ20-125	TJ22-125	TJ23-125
1-1/2	4-1/2	1-1/2	.14	TJ20-150	TJ22-150	TJ23-150
1-3/4	5-1/4	1-3/4	.20	TJ20-175	TJ22-175	TJ23-175
2	6	2	.26	TJ20-200	TJ22-200	TJ23-200
2-1/4	6-3/4	2-1/4	.33	TJ20-225	TJ22-225	TJ23-225
2-3/8	7-1/8	2-3/8	.36	TJ20-237	TJ22-237	TJ23-237
2-1/2	7-1/2	2-1/2	.40	TJ20-250	TJ22-250	TJ23-250
2-3/4	8-1/4	2-3/4	.49	TJ20-275	TJ22-275	TJ23-275
3	9	3	.59	TJ20-300	TJ22-300	TJ23-300
3-1/4	9-3/4	3-1/4	.69	TJ20-325	TJ22-325	TJ23-325
3-1/2	10-1/2	3-1/2	.80	TJ20-350	TJ22-350	TJ23-350
4	12	4	1.05	TJ20-400	TJ22-400	TJ23-400
5	15	5	1.66	TJ20-500	TJ22-500	TJ23-500
6	18	6	2.40	TJ20-600	TJ22-600	TJ23-600

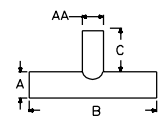
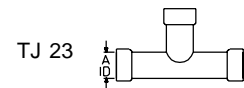
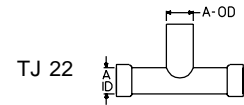
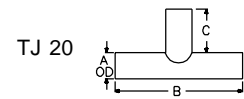

REDUCING T-JOINTS
SPECIFY DEMINSIONS
A, AA, B, C

Dimensions are for Plain End Leg. For Legs with a Bell subtract 1/4" from stated leg length.

Y - JOINTS

A TUBE SIZE	B	C	APPROX. WEIGHT EACH	PART NUMBER		
				STYLE YJ30	STYLE YJ31	STYLE YJ33
3/4	1-1/4	1-1/4	.05	YJ30-075	YJ31-075	YJ33-075
7/8	1-3/8	1-3/8	.06	YJ30-087	YJ31-087	YJ33-087
1	1-1/2	1-1/2	.08	YJ30-100	YJ31-100	YJ33-100
1-1/4	1-3/4	1-3/4	.13	YJ30-125	YJ31-125	YJ33-125
1-1/2	2	2	.18	YJ30-150	YJ31-150	YJ33-150
2	2-1/2	2-1/2	.31	YJ30-200	YJ31-200	YJ33-200
2-1/4	2-3/4	2-3/4	.39	YJ30-225	YJ31-225	YJ33-225
2-3/8	2-7/8	2-7/8	.43	YJ30-237	YJ31-237	YJ33-237
2-1/2	3	3	.48	YJ30-250	YJ31-250	YJ33-250
3	3-1/2	3-1/2	.68	YJ30-300	YJ31-300	YJ33-300
3-1/2	4	4	.91	YJ30-350	YJ31-350	YJ33-350
4	4-1/2	4-1/2	1.18	YJ30-400	YJ31-400	YJ33-400
5	5-1/2	5-1/2	1.83	YJ30-500	YJ31-500	YJ33-500
6	6-1/2	6-1/2	2.61	YJ30-600	YJ31-600	YJ33-600

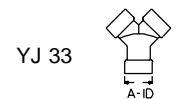
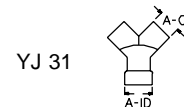
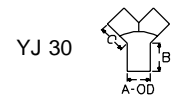

REDUCING Y-JOINTS

A TUBE SIZE	RA TUBE SIZE	B	C	PART NUMBER		
				STYLE RY30	STYLE RY31	STYLE RY33
1- 1/2	1	2	1-1/2	RY30-150100	RY31-150100	RY33-150100
2	1-1/4	2-1/2	1-1/2	RY30-200125	RY31-200125	RY33-200125
2	1-1/2	2-1/2	2	RY30-200150	RY31-200150	RY33-200150
2-1/2	1-1/2	3	2	RY30-250150	RY31-250150	RY33-250150
2-1/2	2	3	2-1/2	RY30-250200	RY31-250200	RY33-250200
3	1-1/2	3-1/2	2	RY30-300150	RY31-300150	RY33-300150
3	2	3-1/2	2-1/2	RY30-300200	RY31-300200	RY33-300200
3	2-1/2	3-1/2	3	RY30-300250	RY31-300250	RY33-300250
3-1/2	3	4	3-1/2	RY30-350300	RY31-350300	RY33-350300
4	3	4-1/2	3-1/2	RY30-400300	RY31-400300	RY33-400300
5	4	5-1/2	4-1/2	RY30-500400	RY31-500400	RY33-500400
6	4	6-1/2	4-1/2	RY30-600400	RY31-600400	RY33-600400
6	5	6-1/2	5-1/2	RY30-600500	RY31-600500	RY33-600500

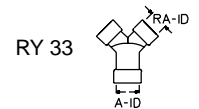
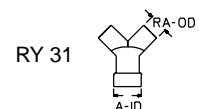
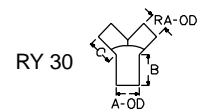

ENTRANCE TUBES

Perfectly Smooth - Pick Free. Standard Main Tube Length is 12 inches. When Ordering, Please Specify: Style Number, Main Tube OD and Inlet Sizes.

TYPICAL DIMENSIONS NEEDED

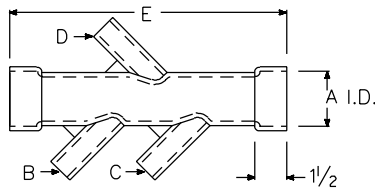

TUBE SIZES

OD	ID
1/2	3/8
5/8	3/8
5/8	1/2
3/4	1/2
3/4	5/8
7/8	5/8
7/8	3/4
1	3/4
1	7/8
1-1/8	7/8
1-1/4	1
1-1/2	1-1/4
1-3/4	1-1/2
2	1-3/4
2-1/4	2
2-3/8	2-1/8
2-1/2	2-1/4
2-3/4	2-1/2
3	2-3/4
3-1/4	3
3-1/2	3-1/4
4	3-3/4
5	4-3/4
6	5-3/4

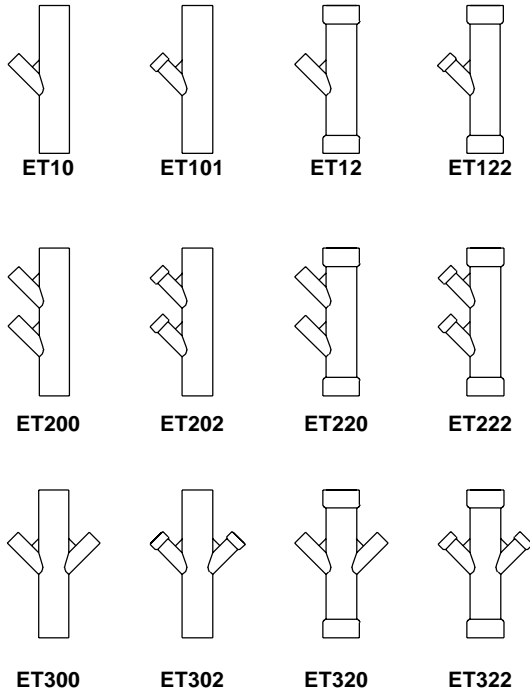

INLINE SLIDE GATES

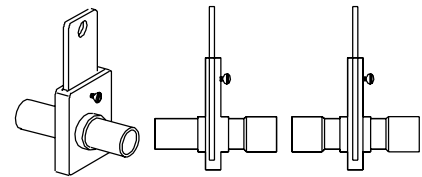

PLAIN END SINGLE BELL DOUBLE BELL

Allows shut-off or regulation of air flow. For use in main or branch lines and for suction or discharge applications. Durable construction with thumb screw lock for gate setting.

TUBE SIZE	PART NUMBER		
	PLAIN ENDS	SINGLE BELL	DOUBLE BELL
1	01150-02	01151-02	01152-02
1-1/8	01150-03	01151-03	01152-03
1-1/4	01150-04	01151-04	01152-04
1-1/2	01150-05	01151-05	01152-05
1-3/4	01150-06	01151-06	01152-06
2	01150-07	01151-07	01152-07
2-1/4	01150-08	01151-08	01152-08
2-3/8	01150-09	01151-09	01152-09
2-1/2	01150-10	01151-10	01152-10
2-3/4	01150-11	01151-11	01152-11
3	01150-12	01151-12	01152-12
3-1/4	01150-13	01151-13	01152-13
3-1/2	01150-14	01151-14	01152-14
4	01150-15	01151-15	01152-15
5	01150-16	01151-16	01152-16
6	01150-17	01151-17	01152-17

TUBE CAPS

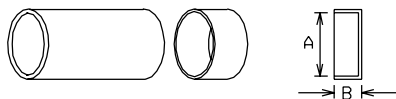

A-FOR TUBE OD	B	PART NUMBER
1/2	1/2	00339-02
5/8	7/8	00339-03
3/4	1/2	00339-04
7/8	1/2	00339-05
1	1/2	00339-06
1-1/8	5/8	00339-07
1-1/4	7/8	00339-08
1-1/2	1	00339-09
1-3/4	1	00339-10
2	1/2	00339-11
2-1/4	5/8	00339-12
2-3/8	1-1/8	00339-13
2-1/2	7/8	00339-14
2-3/4	1	00339-15
3	1	00339-17
3-1/4	1	01149-01
3-1/2	1-1/2	00339-19
4	1-3/8	00339-21
5	2	00339-24
6	2-1/4	00339-25

DAMPERS-VACUUM REGULATORS

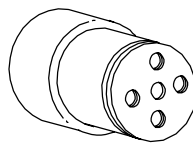

Installs on end of vacuum line. Aids in regulating air velocity.

FOR TUBE (OD)	APPOX. WEIGHT	PART NUMBER
1	.06	DVR100
1-1/4	.07	DVR125
1-1/2	.09	DVR150
1-3/4	.10	DVR175
2	.14	DVR200
2-1/4	.16	DVR225
2-3/8	.19	DVR237
2-1/2	.20	DVR250
2-3/4	.22	DVR275
3	.24	DVR300
3-1/4	.28	DVR325
3-1/2	.32	DVR350
4	.52	DVR400
5	.66	DVR500
6	.80	DVR600

BULK HEAD ADAPTERS

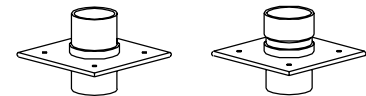

PLAIN END SINGLE BELL

For airtight or weathertight connection to collection containers or through walls.

FOR TUBE OD	PART NUMBER	
	PLAIN END	SINGLE BELL
3/4	01108-01	01111-01
7/8	01108-18	01111-18
1	01108-02	01111-02
1-1/8	01108-03	01111-03
1-1/4	01108-04	01111-04
1-1/2	01108-05	01111-05
1-3/4	01108-06	01111-06
2	01108-07	01111-07
2-1/4	01108-08	01111-08
2-3/8	01108-09	01111-09
2-1/2	01108-10	01111-10
2-3/4	01108-11	01111-11
3	01108-12	01111-12
3.1/4	01108-13	01111-13
3-1/2	01108-17	01111-17
4	01108-14	01111-14
5	01108-15	01111-15
6	01108-16	01111-16

TUBE BRACKETS

All Metal Construction

BRACKET ID

3/4"
7/8"
1"
1-1/4"
1-1/2"
1-3/4"
2"
2-1/4"
2-3/8"
2-1/2"
2-5/8"
2-3/4"
3"
3-1/4"
3-1/2"
4"
5"
6"

00488

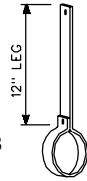

00489

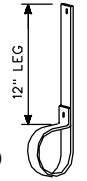

00609

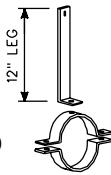

TUBE CLAMPS

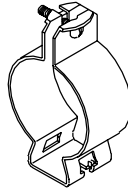

FOR RIGID TUBE (OD)	FOR HOSE (ID)	PART NUMBER
3/4	-	00327-01
1	3/4	00327-02
1-1/4	1	00327-03
1-1/2	1-1/4, 1-1/2	00327-04
1-3/4 - 2	1-3/4	00327-05
2-1/4, 2-3/8	2	00327-06
2-1/2	2-1/4	00327-06M
2-3/4	2-1/2	00327-07
3		00327-07M
3-1/4, 3-1/2	3	00327-08
4		00327-09

MAINTENANCE SUPPLIES



1



2



3

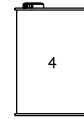

4

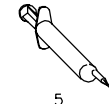

5

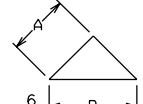

6

ITEM	DESCRIPTION	PART NO.
1	STEEL WOOL	00525
2	DEBURRING TOOL	00587
3	TUBE CEMENT 1-3/4 FL. OZ	00385
4	SOLVENT CEMENT 15 OZ. CAN	00383
5	SYRINGE APPLICATOR	00384
6	BRACE 1-3/16 X 1-11/16	00378
	BRACE 1-3/4 X 2-1/2	05269

HOSE CLAMPS

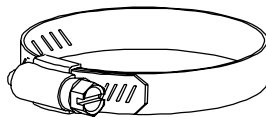

*5/16 BAND WIDTH

CLAMP RANGE REF.			PART NUMBER	CLAMP RANGE REF.			PART NUMBER
MIN	MAX	NUMBER	NUMBER	MIN	MAX	NUMBER	NUMBER
7/32	5/8	HCM-4*	00249-01	1-13/16	2-3/4	HC-36	00249-15
5/16	7/8	HCM-6*	00249-02	2-1/16	3	HC-40	00249-16
9/16	1-1/4	HCM-12*	00249-03	2-5/16	3-1/4	HC-44	00249-17
11/16	1-1/2	HCM-16*	00249-04	2-9/16	3-1/2	HC-48	00249-18
7/8	1-3/4	HCM-20*	00249-05	2-13/16	3-3/4	HC-52	00249-19
3/8	7/8	HC-6	00249-06	3-1/16	4	HC-56	00249-20
7/16	1	HC-8	00249-07	3-5/16	4-1/4	HC-60	00249-21
9/16	1-1/16	HC-10	00249-08	3-9/16	4-1/2	HC-64	00249-22
9/16	1-1/4	HC-12	00249-09	4-1/16	5	HC-72	00249-23
11/16	1-1/2	HC-16	00249-10	4-5/8	5-1/2	HC-80	00249-24
3/4	1-3/4	HC-20	00249-11	4-3/32	6	HC-88	00249-25
1-1/16	2	HC-24	00249-12	4-1/2	6-1/2	HC-96	00249-26
1-5/16	2-1/4	HC-28	00249-13	5	7	HC-104	00249-27
1-9/16	2-1/2	HC-32	00249-14	5-3/4	7-3/4	HC-116	00249-28

VACUUM DIVERTER

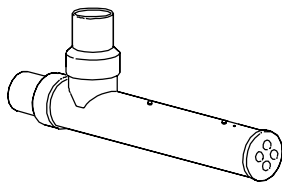

Divertor Unit - Air only. Switches air flow from a vacuum source to a machine / room atmosphere. Designed for use in applications where disrupting or stopping air flow may damage vacuum source. Excellent for use with regenerative blowers or central vacuum system where constant air flow must be maintained.

Unit contains double-acting air cylinder with fittings for 1/4" OD tubing.

FOR TUBE (OD)	PART NO
2"	00802

PRODUCT DIVERTER

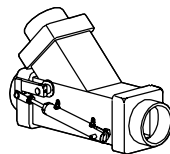

This multiple application unit is designed to divert products from a single source to 2 different locations, or product from 2 different locations to single source. Unit can be used in vacuum (40"S.P.WG) or blowing applications. Unit has aluminum housing, plastic end adapters, double acting air cylinders for switching function, and fittings for 1/4" OD compressed air tubing.

FOR TUBE (OD)	PART NO
2"	04083
2-1/4"	05812
2-3/8"	04034
2-1/2"	00835

PRODUCT DIVERTER

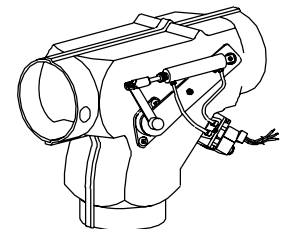

Designed for use with hosiery collection systems to switch product being transported through main line to different destinations. Use with blowing systems only. Unit comes with 110 volt solenoid valve.

DESCRIPTION	PART NO
5" DIVERTER ASSEMBLY	02500
5" DIVERTER LESS SOLINOID VAVLE	02510

IN-LINE WASTE CONTAINERS

- DURABLE, CLEAR PLASTIC FOR EASY VISUAL INSPECTION OF WASTE LEVEL INSIDE FILTER
- REMOVABLE FILTER BASKET FOR QUICK AND EASY EMPTYING OF COLLECTED WASTE
- HIGH QUALITY FOR LONG LIFE - EVEN WHERE OIL IS PRESENT
- STEEL MOUNTING BRACKETS

Especially designed and built for the collection of yarn fibers, thread or small trim. Contaminated air enters through the top inlet cap into the filter where material is collected. The filtered air then travels through the bottom outlet cap to the vacuum system. When Ordering: Please Specify Cap Inlet Sizes.

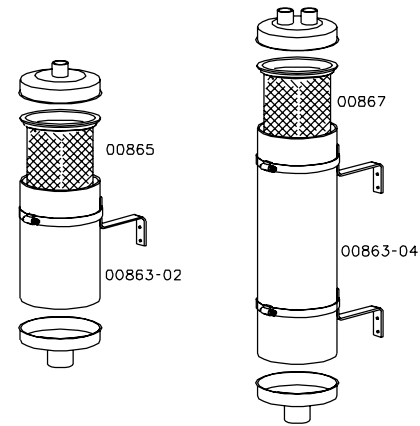

CONTAINER DIAMETER	CONTAINER LENGTH	CAPACITY CUBIC INCHES	ASSEMBLY	ASSEMBLY & MOUNTING BRACKETS
6	12	186	IWC6012	IWC6012-MB
6	24	464	IWC6024	IWC6024-MB

CANISTER CAPS

ENTRANCE QD	CANISTER SIZE DOUBLE INLET	
	5"	6"
5/8	DC5006	DC6006
1	DC5010	DC6010
1-1/4	DC5012	DC6012
1-1/2	DC5015	DC6015

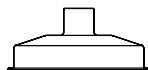

OD	SINGLE INLET	
	5"	6"
5/8	SC5006	SC6006
1	SC5010	SC6010
1-1/4	SC5012	SC6012
1-1/2	SC5015	SC6015
2	SC5020	SC6020
2-1/2	SC5025	SC6025
3	SC5030	SC6030

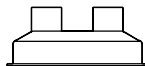

HOSE / TUBE ADAPTERS

HOSE/TUBE SIZE (ID)	A	B	PART NUMBER
7/8"	5/8 ID	7/8 OD	WCA-81
	7/8 OD	7/8 OD	WCA-82
	7/8 OD	1-1/4 OD	WCA-83
1"	5/8 ID	1 OD	WCA-84
	7/8 ID	1 OD	WCA-85
	1 OD	1 ID	WCA-101
	1 OD	1-1/4 ID	WCA-102
1-1/4"	1-1/4 ID	1-1/4 OD	WCA-122
	1-1/4 ID	1-1/4 OD	WCA-122
1-1/2"	1-1/2 OD	1-5/8 ID	RA162150

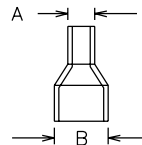

SOUND ATTENUATORS MUFFLERS

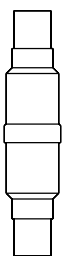

PLAIN END



SINGLE BELL



DOUBLE BELL

Reduces Sound Level. Designed for Material Handling Applications. Excellent for applications where compressed air intake or discharge sound levels are unacceptably high. Smooth bore allows goods or waste to transport through unit without a snag, but traps noise within.

A TUBE SIZE	REF. LENGTH	PART NUMBER		
		PLAIN END	SINGLE BELL	DOUBLE BELL
1	7-1/2	MPL100	MSB100	MDB100
1-1/2	7-1/2	MPL150	MSB150	MDB150
2	7-1/2	MPL200	MSB200	MDB200
2-1/4	16	MPL225	MSB225	MDB225
2-1/2	18	MPL250	MSB250	MDB250
3	18	MPL300	MSB300	MDB300
3-1/2	18	MPL350	MSB350	MDB350

INLINE FILTERS

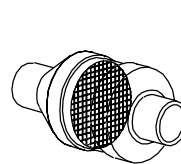

TYPE 1

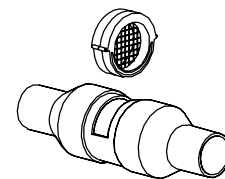

TYPE 2

Designed for use with regenerative blowers & ring compressors. Prevents lint or dust particle build-up which may cause clogging and motor burn-out. Clear construction is ideal for visual control. Use Tempex Reducer couplings or Reducing Adapters to adapt Standard Inline Filters to other tube or hose sizes.

Type 1 Filters Snap Apart to Clean Filter Media. Type 2 Filters Have a Removable Cartridge which Snaps Out for Cleaning.

FOR: TUBE SIZE OD	PART NUMBER	
HOSE SIZE ID	TYPE 1	TYPE 2
2	00734	05702
2-1/4	00652-03	05719
2-1/2	00652-01	05720
3	00652-02	----

CLEAR WIRE REINFORCED VACUUM HOSE

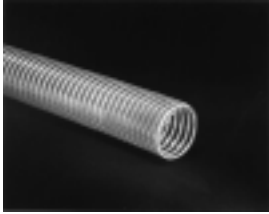

- Reinforced with spring steel
- Smooth inner surface
- Flexible for tight radius bends

PART NUMBER	HOSE (ID)	WEIGHT / FOOT	ROLL LENGTH	CASE QTY	USE HOSE CLAMP
FH750	3/4"	.10	50FT.	100FT.	00249-07
FH875	7/8"	.11	50FT.	250FT.	00249-09
FH100	1"	.12	50FT.	150FT.	00249-09
FH125	1-1/4"	.15	50FT.	200FT.	00249-10
FH150	1-1/2"	.17	50FT.	200FT.	00249-11
FH175	1-3/4"	.31	50FT.	200FT.	00249-12
FH200	2"	.33	50FT.	100FT.	00249-13
FH225	2-1/4"	.35	50FT.	100FT.	00249-14
FH250	2-1/2"	.42	50FT.	50FT.	00249-15
FH300	3"	.46	50FT.	50FT.	00249-17

A high quality/low cost hose that is ideal for medium duty vacuum applications, such as discharge, dust collection and movement of light materials. Clear walls are ideal for visual control.

HEAVY DUTY FLEX HOSE

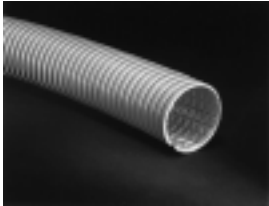

- Reinforced with spring steel
- Smooth inner surface
- Flexible for tight radius bends

PART NUMBER	HOSE (ID)	WEIGHT / FOOT	ROLL LENGTH	CASE QTY	USE HOSE CLAMP
SH-125	1-1/4"	.17	50FT.	200FT.	00249-10
SH-150	1-1/2"	.19	50FT.	200FT.	00249-11
SH-175	1-3/4"	.34	50FT.	100FT.	00249-12
SH-200	2"	.36	50FT.	100FT.	00249-13
SH-225	2-1/4"	.38	50FT.	100FT.	00249-14
SH-250	2-1/2"	.44	50FT.	50FT.	00249-15
SH-300	3"	.46	25FT.	25FT.	00249-17
SH-400	4"	.49	25FT.	25FT.	00249-21

A high quality hose that is ideal for higher vacuum / discharge applications such as dust collection and movement of light materials. Gray color.

POLY FLEX HOSE

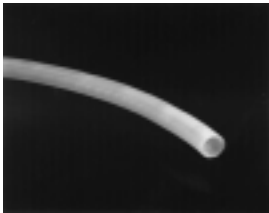

- Highly Oil Resistant
- Lightweight
- Molded Rib for Reinforcement

Stock lengths of 50, 100 and 500 feet.

PART NUMBER	HOSE (ID)	WEIGHT / FOOT	ROLL LENGTH	CASE QTY	USE HOSE CLAMP
PF870	7/8"	.003	50FT.	500FT.	00249-07
PF100	1"	.004	50FT.	500FT.	00249-09

PLASTIC REINFORCED FLEXIBLE VACUUM HOSE



- Reinforced with a Plastic Helix
- Moderately Flexible
- Smooth inner surface

PART NUMBER	HOSE (ID)	WEIGHT / FOOT	ROLL LENGTH	USE HOSE CLAMP
PRH-100	1"	.21	100FT.	00249-10
PRH-125	1-1/4"	.28	100FT.	00249-11
PRH-150	1-1/2"	.23	100FT.	00249-12
PRH-173	1.730"	.44	100FT.	00249-13
PRH-200	2"	.30	100FT.	00249-14
PRH-220	2.200"	.62	100FT.	00249-15
PRH-250	2-1/2"	.39	100FT.	00249-16
PRH-300	3"	.50	100FT.	00249-18
PRH-350	3-1/2"	.62	100FT.	00249-21
PRH-400	4"	.77	100FT.	00249-22
PRH-500	5"	.91	100FT.	00249-25

WORM GEARS / HOSE CLAMPS

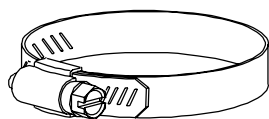

*5/16 Band Width

CLAMP RANGE REF.			PART NUMBER	CLAMP RANGE REF.			PART NUMBER
MIN	MAX	NUMBER		MIN	MAX	NUMBER	
7/32	5/8	HCM-4*	00249-01	1-13/16	2-3/4	HC-36	00249-15
5/16	7/8	HCM-6*	00249-02	2-1/16	3	HC-40	00249-16
9/16	1-1/4	HCM-12*	00249-03	2-5/16	3-1/4	HC-44	00249-17
11/16	1-1/2	HCM-16*	00249-04	2-9/16	3-1/2	HC-48	00249-18
7/8	1-3/4	HCM-20*	00249-05	2-13/16	3-3/4	HC-52	00249-19
3/8	7/8	HC-6	00249-06	3-1/16	4	HC-56	00249-20
7/16	1	HC-8	00249-07	3-5/16	4-1/4	HC-60	00249-21
9/16	1-1/16	HC-10	00249-08	3-9/16	4-1/2	HC-64	00249-22
9/16	1-1/4	HC-12	00249-09	4-1/16	5	HC-72	00249-23
11/16	1-1/2	HC-16	00249-10	4-5/8	5-1/2	HC-80	00249-24
3/4	1-3/4	HC-20	00249-11	4-3/32	6	HC-88	00249-25
1-1/16	2	HC-24	00249-12	4-1/2	6-1/2	HC-96	00249-26
1-5/16	2-1/4	HC-28	00249-13	5	7	HC-104	00249-27
1-9/16	2-1/2	HC-32	00249-14	5-3/4	7-3/4	HC-116	00249-28

CLEAR VINYL TUBING



- LIGHTWEIGHT
- TOUGH
- TRANSPARENT
- NONTOXIC
- SMOOTH
- FLEXIBLE

STANDARD LENGTH - 100 FT.

PART NO.	I.D.	O.D.	WALL	PART NO.	I.D.	O.D.	WALL
VT -015	3/32	5/32	1/32	VT -14	3/8	5/8	1/8
VT -017	1/8	3/16	1/32	VT -18	1/2	5/8	1/16
VT -02	1/8	1/4	1/16	VT -19	1/2	11/16	1/16
VT -025	3/16	1/4	1/32	VT -20	1/2	3/4	1/8
VT -03	3/16	5/16	1/16	VT -22	9/16	3/4	3/32
VT -04	3/16	3/8	3/32	VT -25	5/8	13/16	3/32
VT -05	3/16	7/16	1/8	VT -26	5/8	7/8	1/8
VT -06	1/4	3/8	1/16	VT -31	3/4	1	1/8
VT -07	1/4	7/16	3/32	VT -32	3/4	1-1/16	5/32
VT -08	1/4	1/2	1/8	VT -33	7/8	1-1/8	1/8
VT -09	5/16	7/16	1/16	VT -35	1	1-1/4	1/8
VT -10	5/16	1/2	3/32	VT -37	1	1-3/8	3/16
VT -12	3/8	1/2	1/16	VT -39	1-1/4	1-1/2	3/32

BRAIDED VINYL AIR HOSE



A General Purpose Light-weight Hose made of Clear PVC Reinforced with a Polyester Cord. Use this hose for: Lubrication Lines, Vacuum Lines, Pneumatic Lines, Water Feeds, Glue Lines, and Packaging Machines.

PART NUMBER	I.D.	O.D.	MAXI. W.P. AT 70 DEGREES F.	STANDARD LENGTH
PBH 025	1/4	7/16	225 PSI	50, 100, & 300 FT
PBH 038	3/8	19/32	175 PSI	50, 100, & 300 FT
PBH 050	1/2	23/32	150 PSI	50, 100, & 300 FT
PBH 062	5/8	7/8	125 PSI	50, 100, & 300 FT
PBH 075	3/4	1-1/32	100 PSI	50, 100, & 300 FT
PBH 100	1	1-5/16	85 PSI	50, 100, & 300 FT

DOUBLE - BRAIDED AIR HOSE



Use with: Air Systems, Air Operated Tools, Water Systems, Coolant Lines & Air Activating Devices.

PART NUMBER	I.D.	O.D.	MAXI. W.P. AT 70 DEGREES F.	STANDARD LENGTH
PAH 025	1/4	1/2	250 PSI	50, 100, & 300 FT
PAH 038	3/8	5/8	250 PSI	50, 100, & 300 FT
PAH 050	1/2	13/16	250 PSI	50, 100, & 300 FT

COMPRESSED AIR TUBING

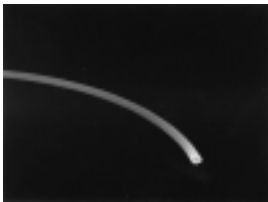

Tubing Color is Natural/White Except as noted.
* Black Only

PART NO.	TUBE OD	TUBE ID	MATERIAL
61118	3.0 MM	1.42 MM	NYLON
61560	4.0 MM	2.7 MM	NYLON
61960	5.0 MM	3.0 MM	NYLON
62320*	6.0 MM	4.0 MM	NYLON
62330*	6.0 MM	4.0 MM	POLYURETHANE
62340	8.0 MM	6.0 MM	NYLON
62350*	10.0 MM	7.5 MM	NYLON
61250	1/8"	.075"	NYLON
61330	3/16"	.137"	NYLON
62400	1/4"	1/8"	POLYETHELENE
62440	1/4"	.170"	POLYETHELENE
62500	5/16"	.232"	NYLON
62550	5/16"	3/16"	POLYETHELENE
62660	3/8"	1/4"	POLYETHELENE
62880	1/2"	3/8"	POLYETHELENE

CABLE TIES

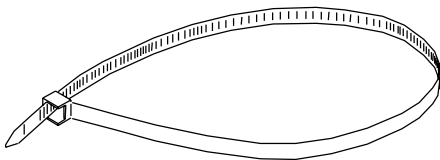

MAX. DIAMETER	LENGTH	PACKAGE QTY.	PART NUMBER
8-1/2	2	25	00572
14-1/4	4	25	00573

TUBE CUTTER

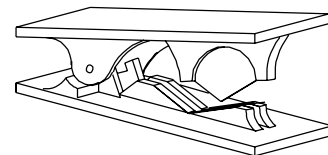

Razor sharp blade assures clean cuts on all types of plastic tubing.

TUBE CUTTER #00570

Male Connector



Part No.	Tube Dia.	Pipe Thread	Price Each
50329	1/8"	10/32"	\$
ACM-25-01	1/4"	1/8"	\$1.04
ACM-25-02	1/4"	1/4"	\$1.28
ACM-38-01	3/8"	1/8"	\$2.16
ACM-38-02	3/8"	1/4"	\$2.16
50299	4mm	10/32"	\$
ACM-M04-01	4mm	1/8"	\$1.12
01756	4mm	M 5	\$
ACM-M06-01	6mm	1/8"	\$1.04
ACM-M06-02	6mm	1/4"	\$1.28
ACM-M10-01	10mm	1/8"	\$2.16
ACM-M10-02	10mm	1/4"	\$2.16

Female Connector

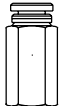

Part No.	Tube Dia.	Pipe Thread	Price Each
ACF-25-01	1/4"	1/8"	\$2.36
ACF-25-02	1/4"	1/4"	\$1.68
ACF-38-01	3/8"	1/8"	\$2.64
ACF-38-02	3/8"	1/4"	\$2.64

Reducing Connector

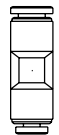

Part No.	Tube Dia.	Tube Dia.	Price Each
ACR-25M04	1/4"	4mm	\$1.36
ACR-3825	3/8"	1/4"	\$1.52
ACR-M06M04	6mm	4mm	\$1.36
ACR-M10M06	10mm	6mm	\$1.52

Union Connector

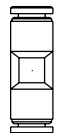

Part No.	Tube Dia.	Price Each
ACU-25	1/4"	\$1.20
ACU-38	3/8"	\$1.84
ACU-M04	4mm	\$1.12
ACU-M06	6mm	\$1.20
ACU-M10	10mm	\$1.84

Male Elbow

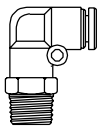

Part No.	Tube Dia.	Pipe Thread	Price Each
AEM-25-01	1/4"	1/8"	\$1.60
AEM-25-02	1/4"	1/4"	\$1.76
AEM-38-01	3/8"	1/8"	\$2.56
AEM-38-02	3/8"	1/4"	\$2.56
AEM-M04-01	4mm	1/8"	\$1.44
AEM-M06-01	6mm	1/8"	\$1.60
AEM-M06-02	6mm	1/4"	\$1.76

Union "Y"

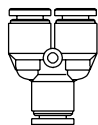

Part No.	Tube Dia.	Price Each
AYU-25	1/4"	\$1.60
AYU-38	3/8"	\$2.56

Reducing "Y"

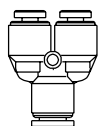

Part No.	"M" Dia.	"B" Dia.	Price Each
AYR-25M04	1/4"	4mm	\$1.84
AYR-3825	3/8"	5/16"	\$2.16
AYR-M06M04	6mm	4mm	\$1.84
AYR-M10M06	10mm	6mm	\$2.16

Union Tee

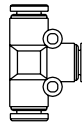

Part No.	Tube Dia.	Price Each
ATU-25	1/4"	\$1.52
ATU-38	3/8"	\$2.48
ATU-M04	4mm	\$1.44
ATU-M06	6mm	\$1.52

Male Street Tee

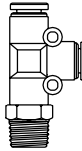

Part No.	Tube Dia.	Pipe Thread	Price Each
ATMS-25-01	1/4"	1/8"	\$2.08
ATMS-25-02	1/4"	1/4"	\$2.16
ATMS-38-01	3/8"	1/8"	\$3.28
ATMS-38-02	3/8"	1/4"	\$3.28
ATMS-M04-01	4mm	1/8"	\$1.76

Flow Control

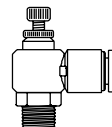

Air
Flow ®

Part No.	Tube Dia.	Pipe Thread	Price Each
50395	1/4"	1/8"	\$4.64

Plug for Auto Fittings



Part No.	Tube Dia.	Price Each
APLG-25	1/4"	\$0.16
APLG-38	3/8"	\$0.24
APLG-M04	4mm	\$0.16
APLG-M06	6mm	\$0.16
APLG-M10	10mm	\$0.24

Male Connector- Barbed

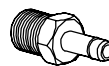

Part No.	Tube Dia.	Pipe Thread	Price Each
00015	1/4"	10/32"	
00105	1/4"	1/8"	
00304	1/4"	1/4"	
00172	3/8"	1/8"	
00526	3/8"	1/4"	

Male Branch Tee- Barbed

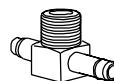

Part No.	Tube Dia.	Pipe Thread	Price Each
00564	1/4"	1/8"	
01968	1/4"	1/4"	
00565	3/8"	1/8"	
00566	3/8"	1/4"	

Male Run Tee- Barbed

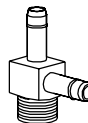

Part No.	Tube Dia.	Pipe Thread	Price Each
50115	1/4"	1/8"	
50118	3/8"	1/8"	

90 Degree Male Elbow- Barbed



Part No.	Tube Dia.	Pipe Thread	Price Each
00095	1/4"	1/8"	
00305	1/4"	1/4"	
00192	3/8"	1/8"	
00527	3/8"	1/4"	

Union Tee- Barbed

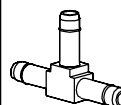

Part No.	Tube Dia.	Pipe Thread	Price Each
00528	1/4"	1/4"	
00529	3/8"	1/4"	
00530	3/8"	3/8"	

Air Filter & Regulator

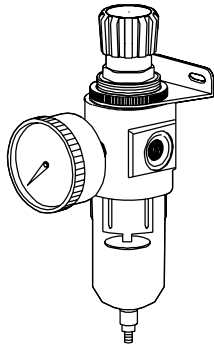

Filter &
Regulator

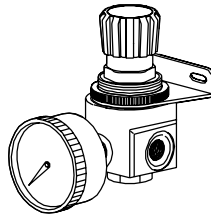

Air
Regulator

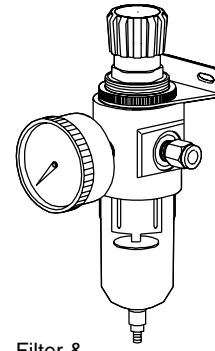

Filter &
Regulator
with Fittings

<u>Part No.</u>	<u>Description</u>	<u>Tube Dia.</u>	<u>Pipe Thread</u>	<u>Price Each</u>
AFR-150	Filter Regulator	-	1/8" NPT	\$26.80
AFR-200	Filter Regulator	-	1/4" NPT	\$26.80
AR-150	Air Regulator	-	1/8" NPT	\$20.40
25825	Filter Reg. w/ Fittings	1/4"	-	\$38.00
25833	Filter Reg. w/ Fittings	3/8"	-	\$39.75

AIR GUN

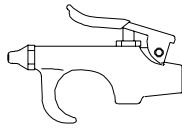

Metal
Air Gun

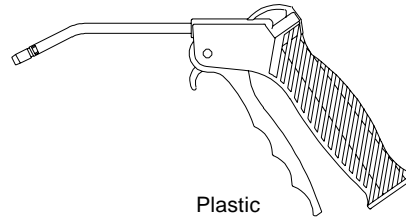

Plastic
Air Gun

<u>Part No.</u>	<u>Description</u>	<u>Price Thread</u>	<u>Each</u>
AGM-1	Air Gun Metal	1/4"	\$7.20
AGP-1	Air Gun Plastic	1/4"	\$5.84

COMPRESSED AIR TUBING

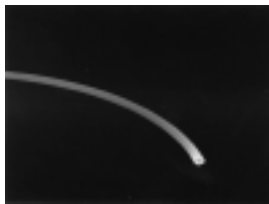

Tubing Color is Natural/White
Except as noted.
* Black Only

<u>PART NO.</u>	<u>TUBE OD</u>	<u>TUBE ID</u>	<u>MATERIAL</u>
61118	3.0 MM	1.42 MM	NYLON
61560	4.0 MM	2.7 MM	NYLON
61960	5.0 MM	3.0 MM	NYLON
62320*	6.0 MM	4.0 MM	NYLON
62330*	6.0 MM	4.0 MM	POLYURETHANE
62340	8.0 MM	6.0 MM	NYLON
62350*	10.0 MM	7.5 MM	NYLON
61250	1/8"	.075"	NYLON
61330	3/16"	.137"	NYLON
62400	1/4"	1/8"	POLYETHELENE
62440	1/4"	.170"	POLYETHELENE
62500	5/16"	.232"	NYLON
62550	5/16"	3/16"	POLYETHELENE
62660	3/8"	1/4"	POLYETHELENE
62880	1/2"	3/8"	POLYETHELENE

TUBE CUTTER

Razor sharp blade assures clean cuts on all types of plastic tubing.

TUBE CUTTER #00570

